

# IGBT for Automotive Application

1200 V, 25 A

## AFGHL25T120RLD

### Description

This Insulated Gate Bipolar Transistor (IGBT) features a robust and cost effective Field Stop II Trench construction. Provides superior performance in demanding switching applications, offering both low on state voltage and minimal switching loss, which is AEC Q101 qualified offer the optimum performance for both hard and soft switching topology in automotive application.

### Features

- Extremely Efficient Trench with Field Stop Technology
- Maximum Junction Temperature:  $T_J = 175^{\circ}\text{C}$
- Short Circuit Withstand Time  $9\ \mu\text{s}$
- 100% of the Parts Tested for  $I_{LM}$  (Note 2)
- Fast Switching
- Tighten Parameter Distribution
- AEC-Q101 Qualified and PPAP Capable
- This Device is Pb-Free, Halogen Free/BFR Free and is RoHS Compliant

### Typical Applications

- Automotive HEV-EV E-Compressor
- Automotive HEV-EV PTC Heater
- Automotive HEV-EV PTC Onboard Chargers
- Automotive HEV-EV DC-DC Converters



ON Semiconductor®

[www.onsemi.com](http://www.onsemi.com)

$V_{CES}$	$I_C$	$V_{CE(Sat)}$
1200 V	25 A	1.73 V (Typ.)

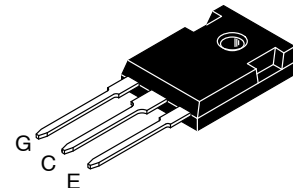
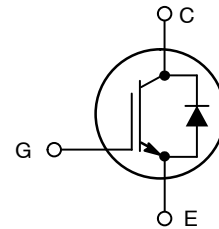

TO-247-3L  
CASE 340CX

### MARKING DIAGRAM

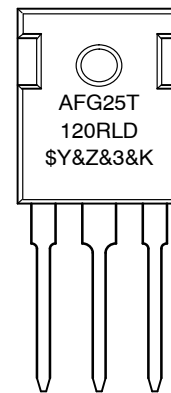

AFG25T120RLD = Specific Device Code  
 \$Y = ON Semiconductor Logo  
 &Z = Assembly Plant Code  
 &3 = 3-Digit Data Code  
 &K = 2-Digit Lot Traceability Code

### ORDERING INFORMATION

Device	Package	Shipping
AFGHL25T120RLD	TO-247-3L	30 Units / Rail

# AFGHL25T120RLD

## ABSOLUTE MAXIMUM RATINGS

Description	Symbol	Value	Units
Collector to Emitter Voltage	$V_{CES}$	1200	V
Gate to Emitter Voltage	$V_{GES}$	$\pm 20$	V
Transient Gate to Emitter Voltage		$\pm 30$	
Collector Current @ $T_C = 25^\circ\text{C}$ (Note 1)	$I_C$	48	A
Collector Current @ $T_C = 100^\circ\text{C}$		25	
Pulsed Collector Current (Note 2)	$I_{LM}$	100	A
Pulsed Collector Current (Note 3)	$I_{CM}$	100	A
Diode Forward Current @ $T_C = 25^\circ\text{C}$ (Note 1)	$I_F$	48	A
Diode Forward Current @ $T_C = 100^\circ\text{C}$		25	
Pulsed Diode Maximum Forward Current	$I_{FM}$	100	A
Maximum Power Dissipation @ $T_C = 25^\circ\text{C}$	$P_D$	400	W
Maximum Power Dissipation @ $T_C = 100^\circ\text{C}$		200	
Short Circuit Withstand Time $V_{GE} = 15\text{ V}, V_{CE} = 600\text{ V}, T_C = 150^\circ\text{C}$	SCWT	9	$\mu\text{s}$
Operating Junction Temperature / Storage Temperature Range	$T_J, T_{STG}$	-55 to +175	$^\circ\text{C}$
Maximum Lead Temp. For Soldering Purposes, $\frac{1}{8}$ " from case for 5 seconds	$T_L$	260	$^\circ\text{C}$

Stresses exceeding those listed in the Maximum Ratings table may damage the device. If any of these limits are exceeded, device functionality should not be assumed, damage may occur and reliability may be affected.

- Value limited by bond wire.
- $V_{CC} = 600\text{ V}, V_{GE} = 15\text{ V}, I_C = 100\text{ A}, R_G = 15\ \Omega$ , Inductive Load, 100% Tested
- Repetitive rating: pulse width limited by max. Junction temperature.

## THERMAL CHARACTERISTICS

Rating	Symbol	Max.	Units
Thermal Resistance, Junction to Case, for IGBT	$R_{\theta JC}$	0.37	$^\circ\text{C/W}$
Thermal Resistance, Junction to Case, Max for Diode	$R_{\theta JC}$	0.63	$^\circ\text{C/W}$
Thermal Resistance, Junction to Ambient, Max	$R_{\theta JA}$	40	$^\circ\text{C/W}$

## ELECTRICAL CHARACTERISTICS ( $T_J = 25^\circ\text{C}$ unless otherwise specified)

Parameter	Test Conditions	Symbol	Min.	Typ.	Max.	Unit
-----------	-----------------	--------	------	------	------	------

### OFF CHARACTERISTICS

Collector-emitter Breakdown Voltage, Gate-emitter Short-circuited	$V_{GE} = 0\text{ V}, I_C = 1\text{ mA}$	$BV_{CES}$	1250	-	-	V
Temperature Coefficient of Breakdown Voltage	$V_{GE} = 0\text{ V}, I_C = 1\text{ mA}$	$\frac{\Delta BV_{CES}}{\Delta T_J}$	-	1.3	-	$\text{V}/^\circ\text{C}$
Collector-emitter Cut-off Current, Gate-emitter Short-circuited	$V_{GE} = 0\text{ V}, V_{CE} = V_{CES}$	$I_{CES}$	-	-	40	$\mu\text{A}$
Gate Leakage Current, Collector-emitter Short-circuited	$V_{GE} = V_{GES}, V_{CE} = 0\text{ V}$	$I_{GES}$	-	-	$\pm 400$	nA

### ON CHARACTERISTICS

Gate-emitter Threshold Voltage	$V_{GE} = V_{CE}, I_C = 25\text{ mA}$	$V_{GE(th)}$	5.1	6.1	7.1	V
Collector-emitter Saturation Voltage	$V_{GE} = 15\text{ V}, I_C = 25\text{ A}$ $V_{GE} = 15\text{ V}, I_C = 25\text{ A}, T_C = 175^\circ\text{C}$	$V_{CE(sat)}$	-	1.73 2.09	2.0 -	V

# AFGHL25T120RLD

## ELECTRICAL CHARACTERISTICS (T<sub>J</sub> = 25°C unless otherwise specified) (continued)

Parameter	Test Conditions	Symbol	Min.	Typ.	Max.	Unit
-----------	-----------------	--------	------	------	------	------

### DYNAMIC CHARACTERISTICS

Input Capacitance	V <sub>CE</sub> = 30 V, V <sub>GE</sub> = 0 V, f = 1 MHz	C <sub>ies</sub>	–	6174	–	pF
Output Capacitance		C <sub>oes</sub>	–	212	–	
Reverse Transfer Capacitance		C <sub>res</sub>	–	114	–	

### SWITCHING CHARACTERISTICS, INDUCTIVE LOAD

Turn-on Delay Time	T <sub>C</sub> = 25°C V <sub>CC</sub> = 600 V, I <sub>C</sub> = 12.5 A R <sub>g</sub> = 5 Ω V <sub>GE</sub> = 15 V Inductive Load	t <sub>d(on)</sub>	–	25.6	–	ns	
Rise Time		t <sub>r</sub>	–	9.6	–		
Turn-off Delay Time		t <sub>d(off)</sub>	–	126.0	–		
Fall Time		t <sub>f</sub>	–	86.0	–		
Turn-on Switching Loss		E <sub>on</sub>	–	0.90	–		mJ
Turn-off Switching Loss		E <sub>off</sub>	–	0.31	–		
Total Switching Loss		E <sub>ts</sub>	–	1.22	–		
Turn-on Delay Time	T <sub>C</sub> = 25°C V <sub>CC</sub> = 600 V, I <sub>C</sub> = 25 A R <sub>g</sub> = 5 Ω V <sub>GE</sub> = 15 V Inductive Load	t <sub>d(on)</sub>	–	27.2	–	ns	
Rise Time		t <sub>r</sub>	–	16.0	–		
Turn-off Delay Time		t <sub>d(off)</sub>	–	116.0	–		
Fall Time		t <sub>f</sub>	–	89.0	–		
Turn-on Switching Loss		E <sub>on</sub>	–	1.94	–		mJ
Turn-off Switching Loss		E <sub>off</sub>	–	0.73	–		
Total Switching Loss		E <sub>ts</sub>	–	2.67	–		
Turn-on Delay Time	T <sub>C</sub> = 175°C V <sub>CC</sub> = 600 V, I <sub>C</sub> = 12.5 A R <sub>g</sub> = 5 Ω V <sub>GE</sub> = 15 V Inductive Load	t <sub>d(on)</sub>	–	24.0	–	ns	
Rise Time		t <sub>r</sub>	–	12.0	–		
Turn-off Delay Time		t <sub>d(off)</sub>	–	144.0	–		
Fall Time		t <sub>f</sub>	–	242.0	–		
Turn-on Switching Loss		E <sub>on</sub>	–	1.42	–		mJ
Turn-off Switching Loss		E <sub>off</sub>	–	0.84	–		
Total Switching Loss		E <sub>ts</sub>	–	2.26	–		
Turn-on Delay Time	T <sub>C</sub> = 175°C V <sub>CC</sub> = 600 V, I <sub>C</sub> = 25 A R <sub>g</sub> = 5 Ω V <sub>GE</sub> = 15 V Inductive Load	t <sub>d(on)</sub>	–	28.0	–	ns	
Rise Time		t <sub>r</sub>	–	16.0	–		
Turn-off Delay Time		t <sub>d(off)</sub>	–	131.0	–		
Fall Time		t <sub>f</sub>	–	213.0	–		
Turn-on Switching Loss		E <sub>on</sub>	–	2.87	–		mJ
Turn-off Switching Loss		E <sub>off</sub>	–	1.7	–		
Total Switching Loss		E <sub>ts</sub>	–	4.54	–		
Total Gate Charge	V <sub>CE</sub> = 600 V, I <sub>C</sub> = 25 A, V <sub>GE</sub> = 15 V	Q <sub>g</sub>	–	277	–	nC	
Gate to Emitter Charge		Q <sub>ge</sub>	–	53	–		
Gate to collector Charge		Q <sub>gc</sub>	–	146	–		

### DIODE CHARACTERISTICS

Forward Voltage	I <sub>F</sub> = 25 A, T <sub>C</sub> = 25°C I <sub>F</sub> = 25 A, T <sub>C</sub> = 175°C	V <sub>F</sub>	– –	1.43 1.44	2.0 –	V
Reverse Recovery Energy	T <sub>C</sub> = 25°C V <sub>R</sub> = 600 V, I <sub>F</sub> = 12.5 A, dI <sub>F</sub> /dt = 1000 A/μs	E <sub>rec</sub>	–	0.46	–	mJ
Reverse Recovery Time		T <sub>rr</sub>	–	112	–	ns
Reverse Recovery Charge		Q <sub>rr</sub>	–	1538	–	nC

# AFGHL25T120RLD

## ELECTRICAL CHARACTERISTICS ( $T_J = 25^\circ\text{C}$ unless otherwise specified) (continued)

Parameter	Test Conditions	Symbol	Min.	Typ.	Max.	Unit
<b>DIODE CHARACTERISTICS</b>						
Reverse Recovery Energy	$T_C = 25^\circ\text{C}$ $V_R = 600\text{ V}$ , $I_F = 25\text{ A}$ , $di_F/dt = 1000\text{ A}/\mu\text{s}$	$E_{rec}$	–	0.75	–	mJ
Reverse Recovery Time		$T_{rr}$	–	159	–	ns
Reverse Recovery Charge		$Q_{rr}$	–	2429	–	nC
Reverse Recovery Energy	$T_C = 175^\circ\text{C}$ $V_R = 600\text{ V}$ , $I_F = 12.5\text{ A}$ , $di_F/dt = 1000\text{ A}/\mu\text{s}$	$E_{rec}$	–	1.13	–	mJ
Reverse Recovery Time		$T_{rr}$	–	185	–	ns
Reverse Recovery Charge		$Q_{rr}$	–	3241	–	nC
Reverse Recovery Energy	$T_C = 175^\circ\text{C}$ $V_R = 600\text{ V}$ , $I_F = 25\text{ A}$ , $di_F/dt = 1000\text{ A}/\mu\text{s}$	$E_{rec}$	–	1.48	–	mJ
Reverse Recovery Time		$T_{rr}$	–	214	–	ns
Reverse Recovery Charge		$Q_{rr}$	–	4233	–	nC

Product parametric performance is indicated in the Electrical Characteristics for the listed test conditions, unless otherwise noted. Product performance may not be indicated by the Electrical Characteristics if operated under different conditions.

# AFGHL25T120RLD

## TYPICAL CHARACTERISTICS

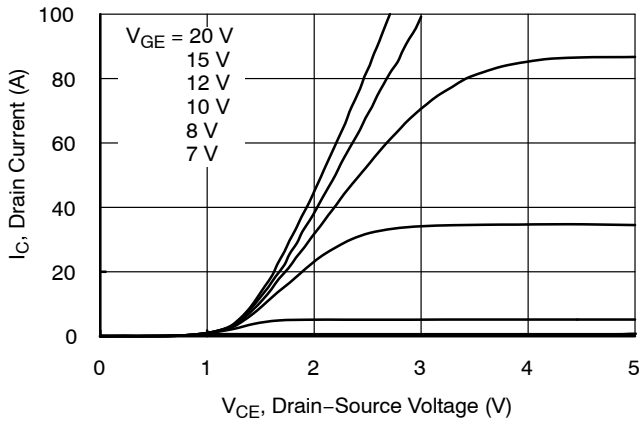

Figure 1. Typical Output Characteristics (25°C)

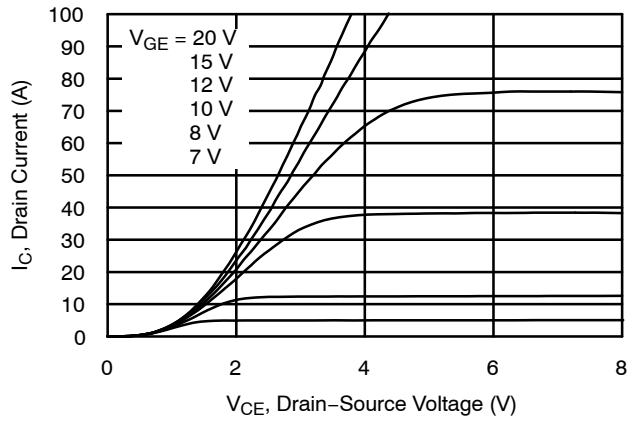

Figure 2. Typical Output Characteristics (175°C)

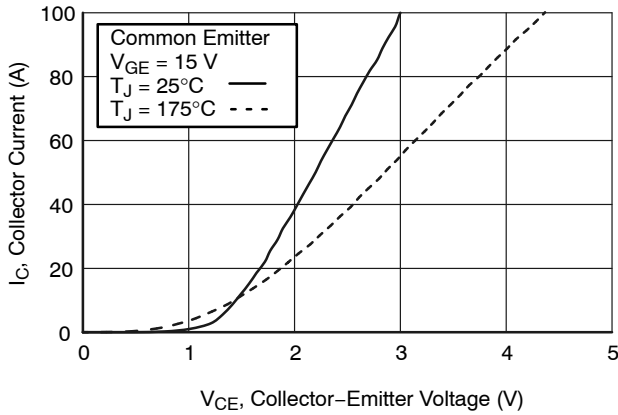

Figure 3. Typical Saturation Voltage Characteristics

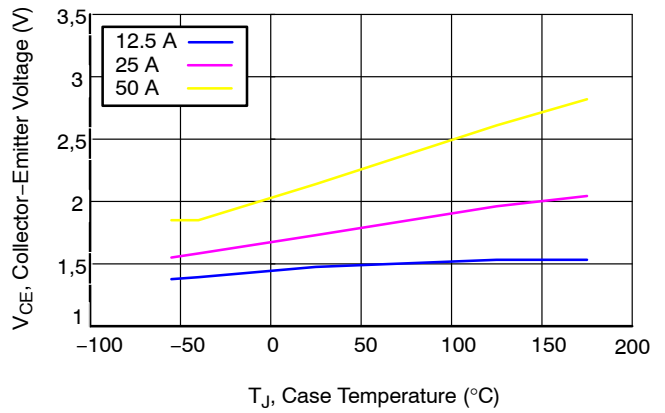

Figure 4. Saturation Voltage vs. Case Temperature at Variant Current Level

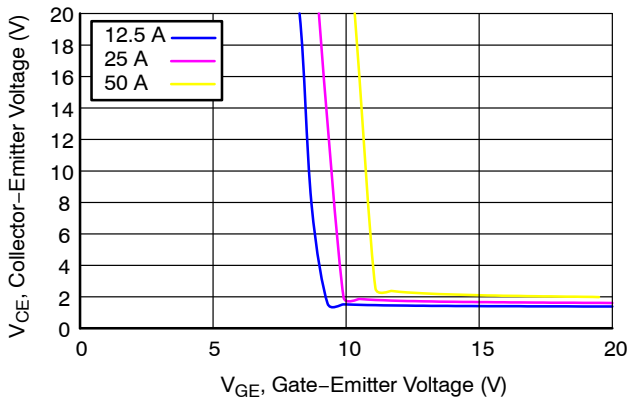

Figure 5. Saturation Voltage vs.  $V_{GE}$  (25°C)

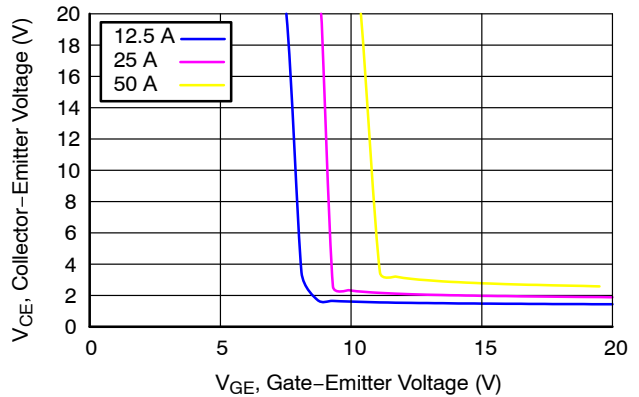

Figure 6. Saturation Voltage vs.  $V_{GE}$  (175°C)

# AFGHL25T120RLD

## TYPICAL CHARACTERISTICS (continued)

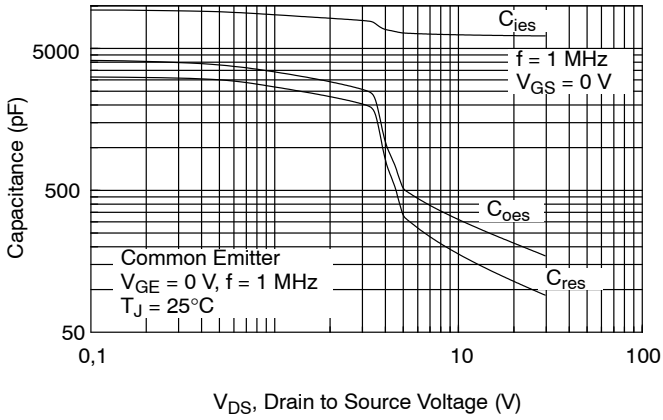

Figure 7. Capacitance Characteristics

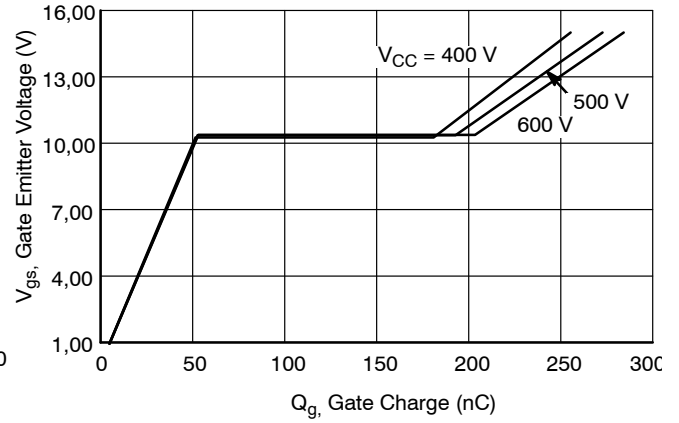

Figure 8. Gate Charge Characteristics

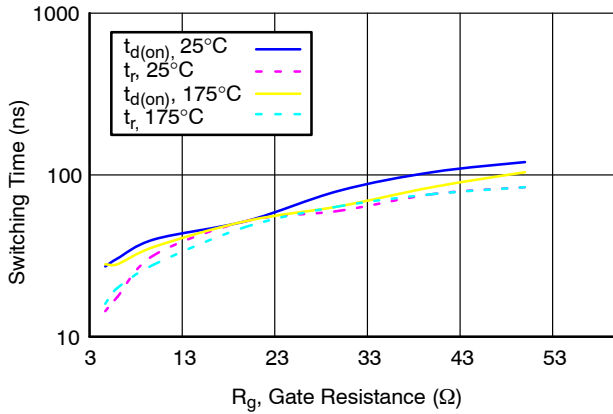

Figure 9. Turn-on Characteristics vs. Gate Resistance

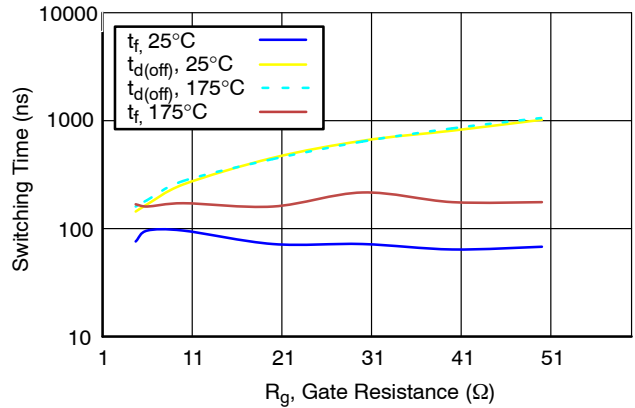

Figure 10. Turn-off Characteristics vs. Gate Resistance

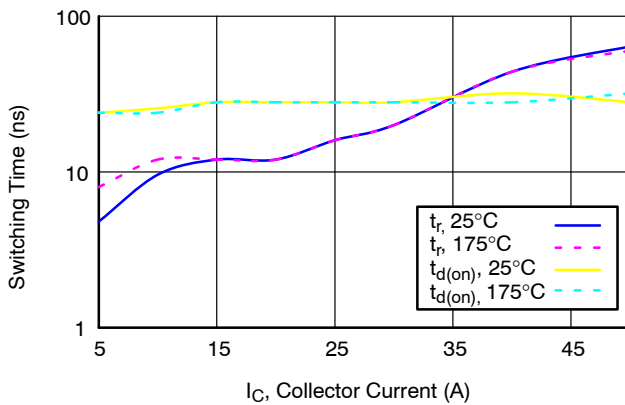

Figure 11. Turn-on Characteristics vs. Collector Current

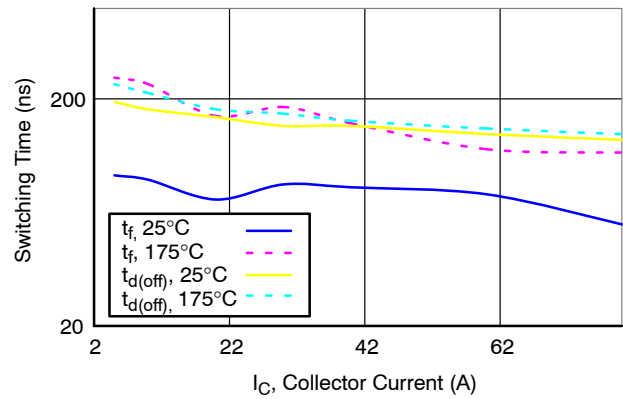

Figure 12. Turn-off Characteristics vs. Collector Current

# AFGHL25T120RLD

## TYPICAL CHARACTERISTICS (continued)

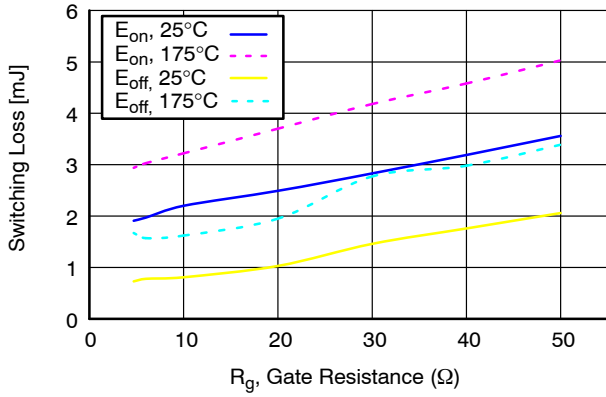

Figure 13. Switching Loss vs. Gate Resistance

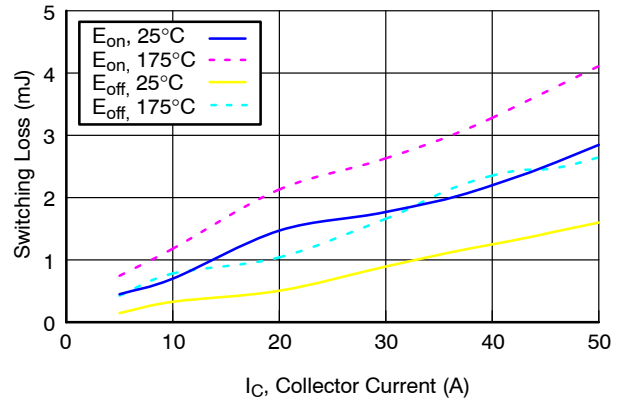

Figure 14. Switching Loss vs. Collector Current

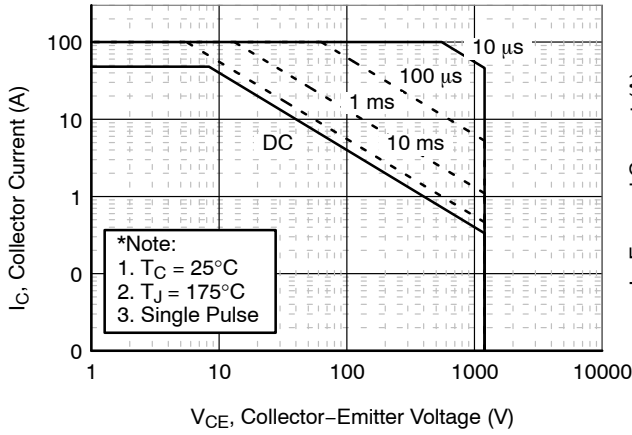

Figure 15. SOA Characteristics

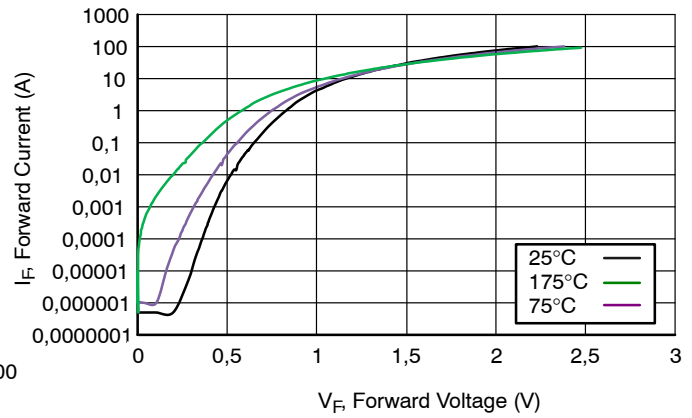

Figure 16. Forward Characteristics

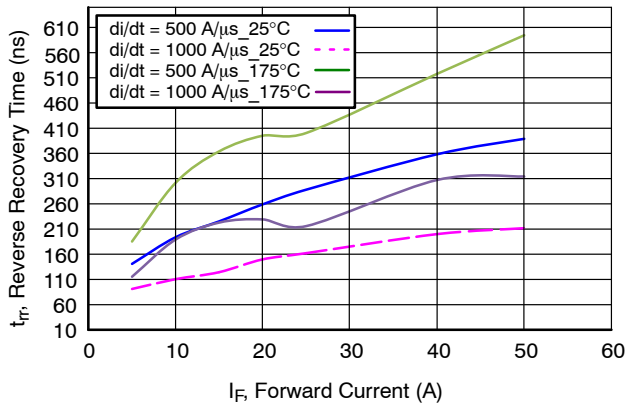

Figure 17. Reverse Recovery Time

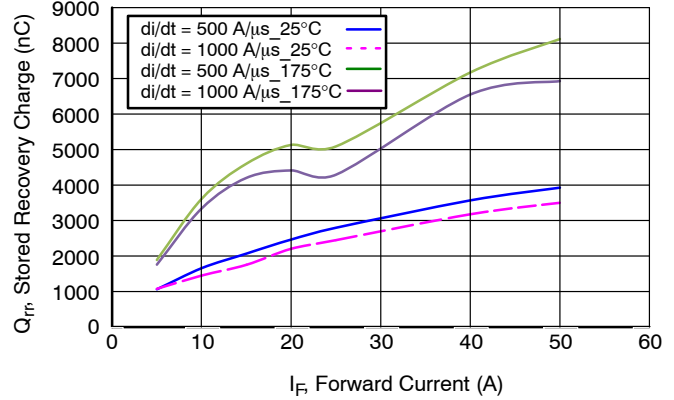

Figure 18. Stored Charge

# AFGHL25T120RLD

## TYPICAL CHARACTERISTICS (continued)

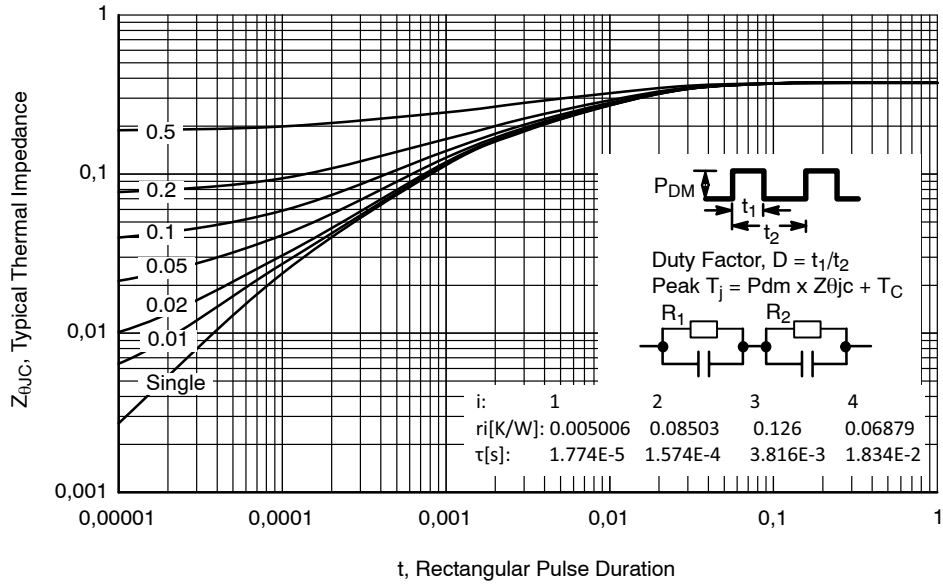

Figure 19. Transient Thermal Impedance of IGBT

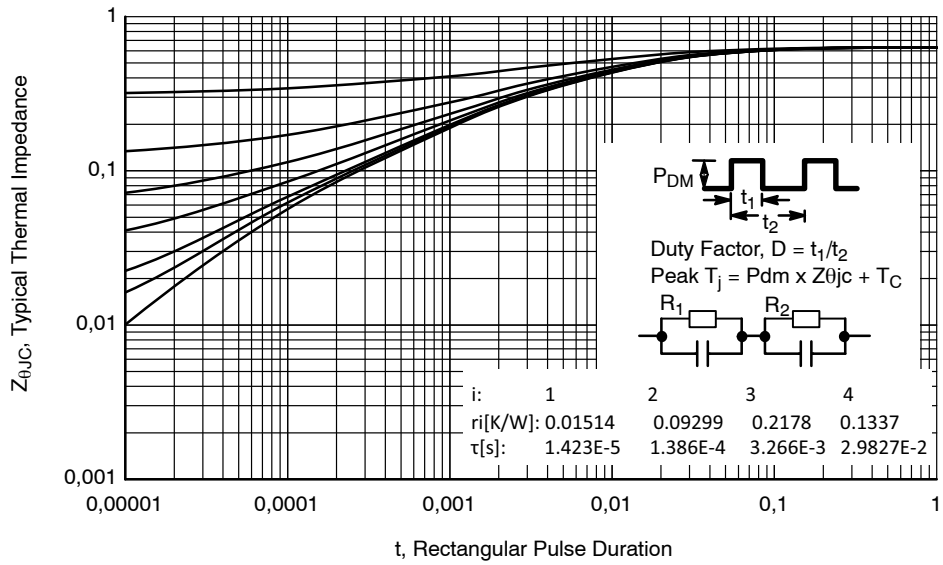

Figure 20. Transient Thermal Impedance of Diode



# AFGHL25T120RLD

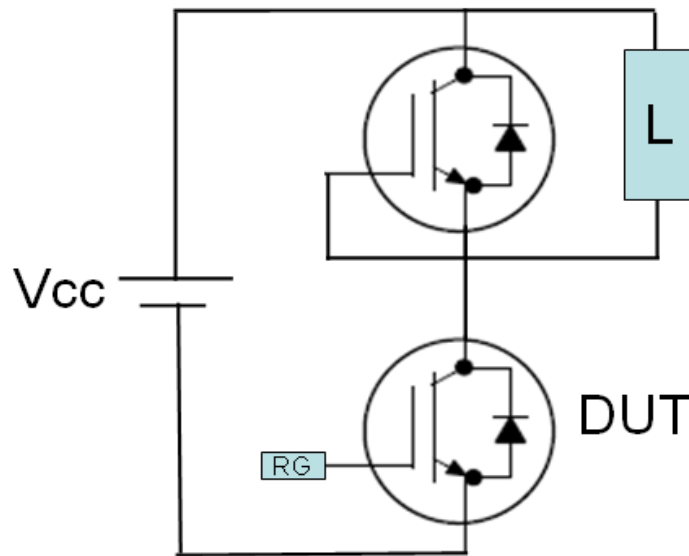

Figure 21. Test Circuit for Switching Characteristics

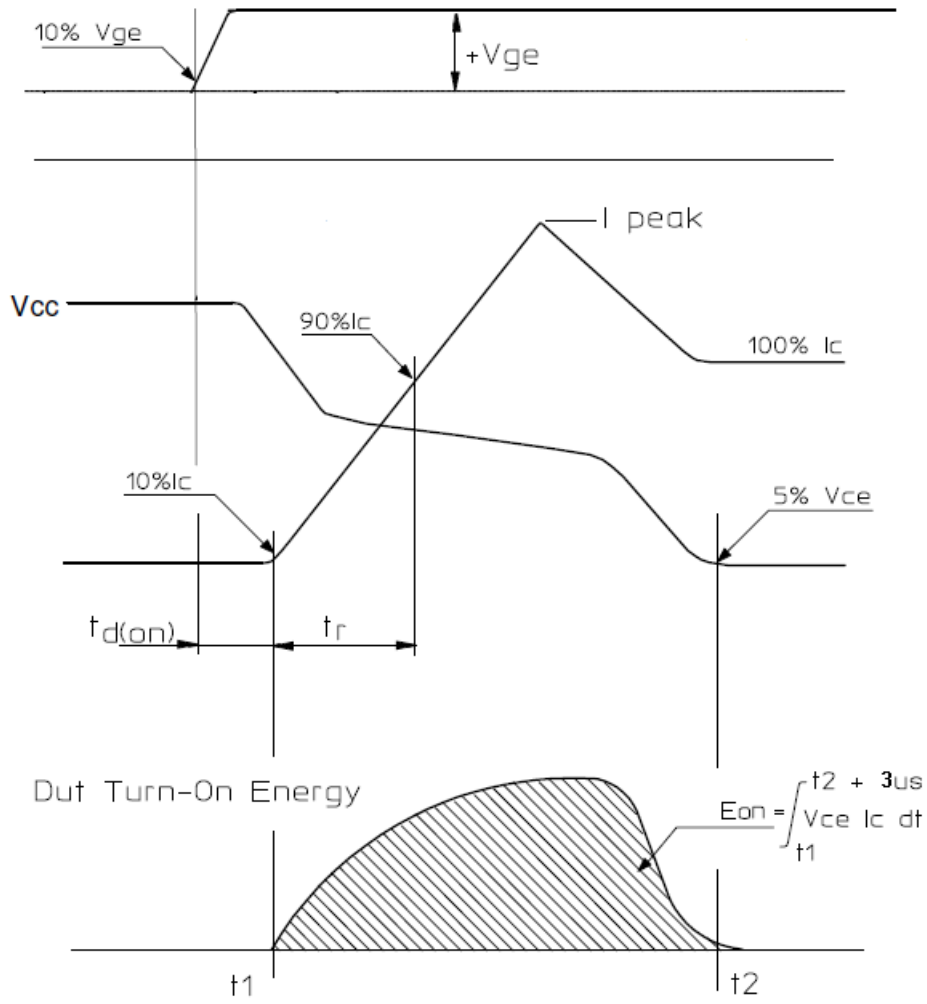

Figure 22. Definition of Turn On Waveform



Figure 23. Definition of Turn Off Waveform

**TO-247-3LD**  
**CASE 340CX**  
**ISSUE A**

DATE 06 JUL 2020

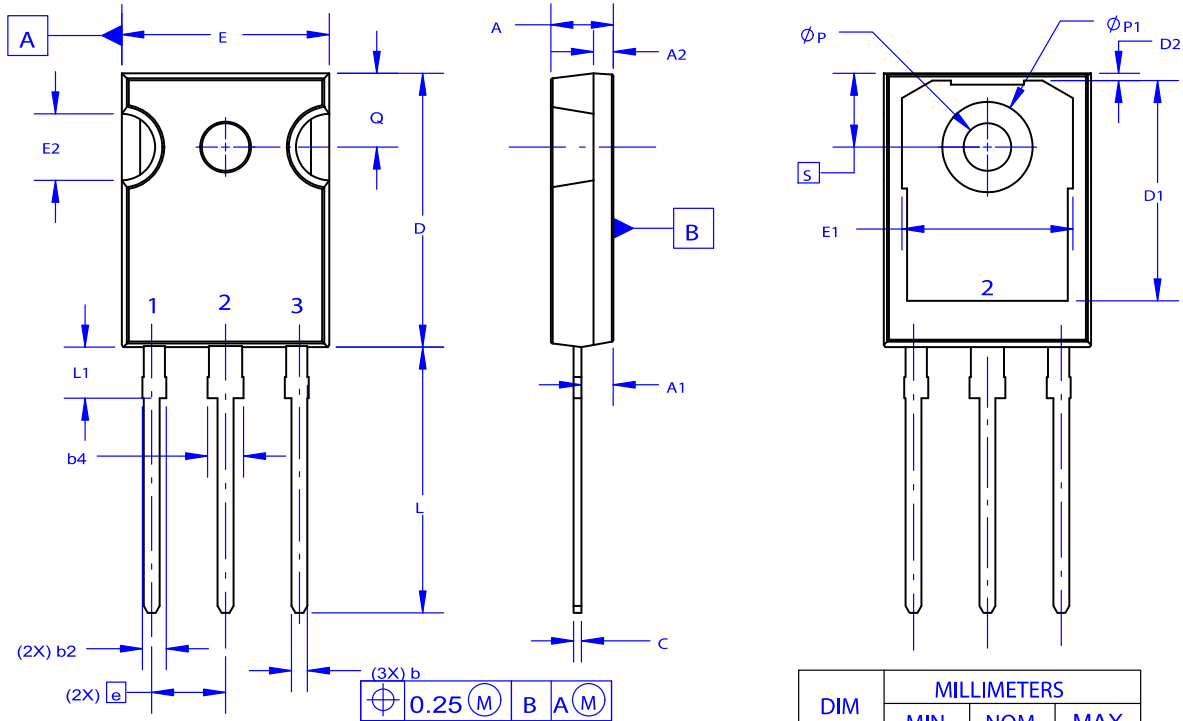
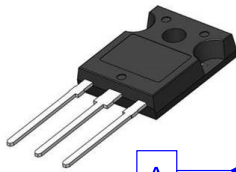

NOTES: UNLESS OTHERWISE SPECIFIED.

- A. DIMENSIONS ARE EXCLUSIVE OF BURRS, MOLD FLASH, AND TIE BAR EXTRUSIONS.
- B. ALL DIMENSIONS ARE IN MILLIMETERS.
- C. DRAWING CONFORMS TO ASME Y14.5 - 2009.
- D. DIMENSION A1 TO BE MEASURED IN THE REGION DEFINED BY L1.
- E. LEAD FINISH IS UNCONTROLLED IN THE REGION DEFINED BY L1.

**GENERIC MARKING DIAGRAM\***



- XXXXX = Specific Device Code
- A = Assembly Location
- Y = Year
- WW = Work Week
- G = Pb-Free Package

\*This information is generic. Please refer to device data sheet for actual part marking. Pb-Free indicator, "G" or microdot "▪", may or may not be present. Some products may not follow the Generic Marking.

DIM	MILLIMETERS		
	MIN	NOM	MAX
A	4.58	4.70	4.82
A1	2.20	2.40	2.60
A2	1.40	1.50	1.60
D	20.32	20.57	20.82
E	15.37	15.62	15.87
E2	4.96	5.08	5.20
e	~	5.56	~
L	19.75	20.00	20.25
L1	3.69	3.81	3.93
ØP	3.51	3.58	3.65
Q	5.34	5.46	5.58
S	5.34	5.46	5.58
b	1.17	1.26	1.35
b2	1.53	1.65	1.77
b4	2.42	2.54	2.66
c	0.51	0.61	0.71
D1	13.08	~	~
D2	0.51	0.93	1.35
E1	12.81	~	~
ØP1	6.60	6.80	7.00

<b>DOCUMENT NUMBER:</b>	<b>98AON93302G</b>	Electronic versions are uncontrolled except when accessed directly from the Document Repository. Printed versions are uncontrolled except when stamped "CONTROLLED COPY" in red.
<b>DESCRIPTION:</b>	<b>TO-247-3LD</b>	<b>PAGE 1 OF 1</b>

onsemi and Onsemi are trademarks of Semiconductor Components Industries, LLC dba onsemi or its subsidiaries in the United States and/or other countries. onsemi reserves the right to make changes without further notice to any products herein. onsemi makes no warranty, representation or guarantee regarding the suitability of its products for any particular purpose, nor does onsemi assume any liability arising out of the application or use of any product or circuit, and specifically disclaims any and all liability, including without limitation special, consequential or incidental damages. onsemi does not convey any license under its patent rights nor the rights of others.

**onsemi**, **Onsemi**, and other names, marks, and brands are registered and/or common law trademarks of Semiconductor Components Industries, LLC dba "**onsemi**" or its affiliates and/or subsidiaries in the United States and/or other countries. **onsemi** owns the rights to a number of patents, trademarks, copyrights, trade secrets, and other intellectual property. A listing of **onsemi**'s product/patent coverage may be accessed at [www.onsemi.com/site/pdf/Patent-Marking.pdf](http://www.onsemi.com/site/pdf/Patent-Marking.pdf). **onsemi** reserves the right to make changes at any time to any products or information herein, without notice. The information herein is provided "as-is" and **onsemi** makes no warranty, representation or guarantee regarding the accuracy of the information, product features, availability, functionality, or suitability of its products for any particular purpose, nor does **onsemi** assume any liability arising out of the application or use of any product or circuit, and specifically disclaims any and all liability, including without limitation special, consequential or incidental damages. Buyer is responsible for its products and applications using **onsemi** products, including compliance with all laws, regulations and safety requirements or standards, regardless of any support or applications information provided by **onsemi**. "Typical" parameters which may be provided in **onsemi** data sheets and/or specifications can and do vary in different applications and actual performance may vary over time. All operating parameters, including "Typicals" must be validated for each customer application by customer's technical experts. **onsemi** does not convey any license under any of its intellectual property rights nor the rights of others. **onsemi** products are not designed, intended, or authorized for use as a critical component in life support systems or any FDA Class 3 medical devices or medical devices with a same or similar classification in a foreign jurisdiction or any devices intended for implantation in the human body. Should Buyer purchase or use **onsemi** products for any such unintended or unauthorized application, Buyer shall indemnify and hold **onsemi** and its officers, employees, subsidiaries, affiliates, and distributors harmless against all claims, costs, damages, and expenses, and reasonable attorney fees arising out of, directly or indirectly, any claim of personal injury or death associated with such unintended or unauthorized use, even if such claim alleges that **onsemi** was negligent regarding the design or manufacture of the part. **onsemi** is an Equal Opportunity/Affirmative Action Employer. This literature is subject to all applicable copyright laws and is not for resale in any manner.

## ADDITIONAL INFORMATION

### TECHNICAL PUBLICATIONS:

Technical Library: [www.onsemi.com/design/resources/technical-documentation](http://www.onsemi.com/design/resources/technical-documentation)  
onsemi Website: [www.onsemi.com](http://www.onsemi.com)

### ONLINE SUPPORT: [www.onsemi.com/support](http://www.onsemi.com/support)

For additional information, please contact your local Sales Representative at [www.onsemi.com/support/sales](http://www.onsemi.com/support/sales)

